

IP67 WATERPROOF DIGITAL CALIPERS

INSIZE PLUS
MADE IN EUROPE

INSPECTION
CERTIFICATE

DATA
OUTPUT

IP67
WATERPROOF

2

- IP67 dust/waterproof
- Resolution: 0.01mm/0.0005"
- Button function: zero, mm/inch, preset, data output
- Battery CR2032
- Automatic power off, move the digital unit to turn on power
- Data output
- Meet DIN862
- Made of stainless steel
- Optional accessory:
 - wireless transmitter code **7315-80** (receiver is needed) page 7,
 - data output cable code **7302-80**,
 - accessory set for digital calipers (code **6144**, only for range 0-150mm and 0-200mm),
 - depth base attachment (code **6140**)



1195-150

Code	Range	Accuracy	Thumb roller	L	a	b	c	d	Remark
1195-150*	0-150mm/0-6"	±0.02mm	with	235	21	16.5	16	40	with depth bar
1195-200*	0-200mm/0-8"	±0.03mm	with	290	24.5	20	16	50	with depth bar
1195-300*	0-300mm/0-12"	±0.03mm	with	387	23	18.5	16	64	without depth bar

(mm)

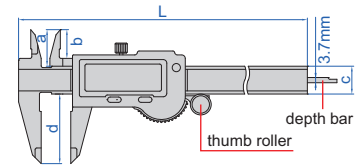

* Supplied with manufacturer inspection certificate

IP67 WATERPROOF DIGITAL CALIPERS

ATTENTION: IT IS NECESSARY TO SET
ZERO AFTER POWER ON EACH TIME

ATTENTION:
NO DATA OUTPUT

IP67
WATERPROOF

INSPECTION
CERTIFICATE



1118-150B

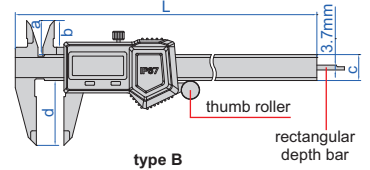

type B

- IP67 dust/waterproof
- Resolution: 0.01mm/0.0005"
- Button function: zero, on/off, mm/inch, ABS/REL, hold
- Battery CR2032
- Meet DIN862
- Made of stainless steel
- Optional accessory:
 - accessory set for digital calipers (code **6144**, only for range 0-150mm and 0-200mm),
 - depth base attachment (code **6140**)



1118-150R

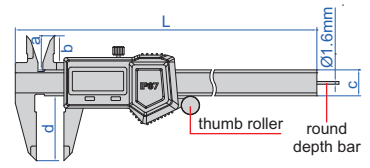

type R

Code	Range	Accuracy	Thumb roller	Type	L	a	b	c	d
1118-150B*	0-150mm/0-6"	±0.03mm	with	B	236mm	21mm	16mm	16mm	40mm
1118-200B*	0-200mm/0-8"	±0.03mm	with	B	286mm	24mm	19mm	16mm	50mm
1118-300B*	0-300mm/0-12"	±0.03mm	with	B	400mm	25mm	20.5mm	16mm	60mm
1118-150BW*	0-150mm/0-6"	±0.03mm	without	B	236mm	21mm	16mm	16mm	40mm
1118-200BW*	0-200mm/0-8"	±0.03mm	without	B	286mm	24mm	19mm	16mm	50mm
1118-300BW*	0-300mm/0-12"	±0.03mm	without	B	400mm	25mm	20.5mm	16mm	60mm
1118-150R*	0-150mm/0-6"	±0.03mm	with	R	236mm	21mm	16mm	16mm	40mm
1118-150RW*	0-150mm/0-6"	±0.03mm	without	R	236mm	21mm	16mm	16mm	40mm

* Supplied with manufacturer inspection certificate

ATTENTION: THE WORKING LIFE OF A BATTERY IS ABOUT 3-5 MONTHS

WIRELESS DIGITAL CALIPERS (ZIGBEE)

INSPECTION CERTIFICATE

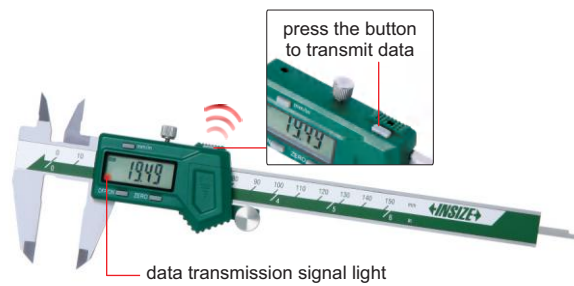

1113-150

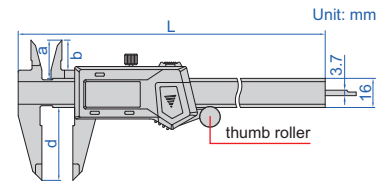

Unit: mm

- Non waterproof
- Built-in wireless data transmission module, Zigbee signal
- Transmission distance is 10 meter (under the condition of no obstruction and no electromagnetic interference)
- Resolution: 0.01mm/0.0005"
- Buttons: on/off, zero, mm/inch, data transmission
- Automatic power off, move the digital unit to turn on power
- Battery CR2032
- Made of stainless steel
- Optional accessory: receiver (code 7315-2/3/6/7/8/9), accessory set for digital calipers (code 6144, only for range 0-150mm and 0-200mm), depth base attachment (code 6140)

application

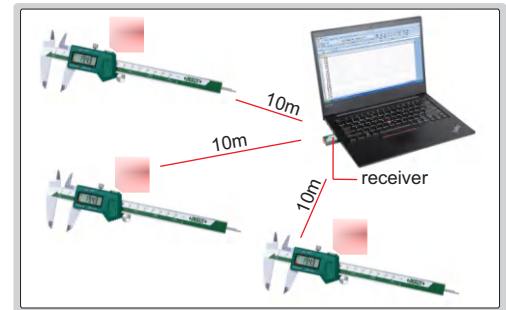

Code	Range	Accuracy	Thumb roller	L	a	b	d
1113-150 *	0-150mm/0-6"	±0.03mm	with	236	21	16	40
1113-200 *	0-200mm/0-8"	±0.03mm	with	286	24	19	50
1113-300 *	0-300mm/0-12"	±0.03mm	with	400	25	20.5	60
1113-150W *	0-150mm/0-6"	±0.03mm	without	236	21	16	40
1113-200W *	0-200mm/0-8"	±0.03mm	without	286	24	19	50
1113-300W *	0-300mm/0-12"	±0.03mm	without	400	25	20.5	60

(mm)

receiver (optional)

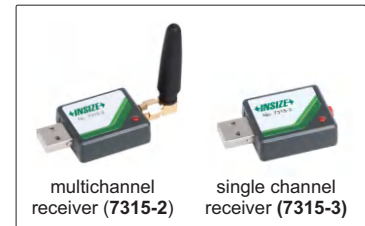

multichannel receiver (7315-2)

single channel receiver (7315-3)

* Supplied with manufacturer inspection certificate

POPULAR MODEL

DIGITAL CALIPERS (STANDARD TYPE)

- Non waterproof
- Resolution: 0.01mm/0.0005"
- Buttons: on/off, zero, mm/inch
- Automatic power off, move the digital unit to turn on power
- Battery CR2032
- Data output
- Meet DIN862
- Made of stainless steel
- Optional accessory: wireless transmitter code 7315-25 (receiver is needed) page 5, bluetooth transmitter code 7214-25 page 11, data output cable code 7302-21 page 20, accessory set for digital calipers (code 6144, only for range 0-150mm and 0-200mm), depth base attachment (code 6140)

INSPECTION CERTIFICATE

DATA OUTPUT



1108-150

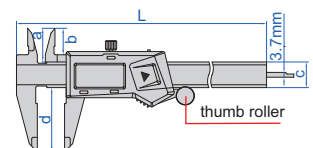

Code	Range	Accuracy	Thumb roller	L	a	b	c	d
1108-150 *	0-150mm/0-6"	±0.02mm	with	236mm	21mm	16mm	16mm	40mm
1108-200 *	0-200mm/0-8"	±0.03mm	with	286mm	24mm	19mm	16mm	50mm
1108-250 *	0-250mm/0-10"	±0.03mm	with	350mm	25mm	20.5mm	16mm	60mm
1108-300 *	0-300mm/0-12"	±0.03mm	with	400mm	25mm	20.5mm	16mm	60mm
1108-150W *	0-150mm/0-6"	±0.02mm	without	236mm	21mm	16mm	16mm	40mm
1108-200W *	0-200mm/0-8"	±0.03mm	without	286mm	24mm	19mm	16mm	50mm
1108-300W *	0-300mm/0-12"	±0.03mm	without	400mm	25mm	20.5mm	16mm	60mm

* Supplied with manufacturer inspection certificate

DIGITAL CALIPERS (ABSOLUTE SYSTEM)

INSPECTION
CERTIFICATE

DATA
OUTPUT

2

- Non waterproof
- Absolute system, low power consumption, long battery life
- Resolution: 0.01mm/0.0005"
- Buttons: on/off, mm/inch, ORIGIN, ZERO/ABS
- Automatic power off, move the digital unit to turn on power
- Battery CR2032
- Data output
- Meet DIN862
- Made of stainless steel
- Optional accessory:
wireless transmitter code **7315-22** (receiver is needed) page 5,
bluetooth transmitter code **7214-22** page 11,
data output cable code **7302-22** page 20,
accessory set for digital calipers (code **6144**, only for range 0-150mm and 0-200mm),
depth base attachment (code **6140**)



1103-150

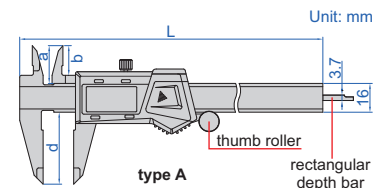

Code	Range	Accuracy	Thumb roller	Type	L	a	b	d
1103-150*	0-150mm/0-6"	±0.03mm	with	A	236mm	21mm	16.5mm	40mm
1103-200*	0-200mm/0-8"	±0.03mm	with	A	286mm	24mm	19.5mm	50mm
1103-300*	0-300mm/0-12"	±0.03mm	with	A	400mm	26mm	21.5mm	60mm
1103-150W*	0-150mm/0-6"	±0.03mm	without	A	236mm	21mm	16.5mm	40mm
1103-200W*	0-200mm/0-8"	±0.03mm	without	A	286mm	24mm	19.5mm	50mm
1103-300W*	0-300mm/0-12"	±0.03mm	without	A	400mm	26mm	21.5mm	60mm
1103-150R*	0-150mm/0-6"	±0.03mm	with	R	236mm	21mm	16.5mm	40mm
1103-150RW*	0-150mm/0-6"	±0.03mm	without	R	236mm	21mm	16.5mm	40mm

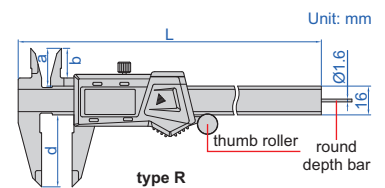

*Supplied with manufacturer inspection certificate

DIGITAL CALIPERS

INSPECTION
CERTIFICATE

ATTENTION:
NO DATA OUTPUT

- Non waterproof
- Zinc alloy housing for digital unit
- Resolution: 0.01mm/0.0005"
- Buttons: zero, on/off, mm/inch
- Automatic power off, move the digital unit to turn on power
- Battery CR2032
- Meet DIN862
- Made of stainless steel
- Optional accessory:
accessory set for digital calipers
(code **6144**, only for range 0-150mm and 0-200mm),
depth base attachment (code **6140**)



1114-150A

Code	Range	Accuracy	Thumb roller	L	a	b	c	d
1114-150A*	0-150mm/0-6"	±0.03mm	with	236mm	21mm	16mm	16mm	40mm
1114-200A*	0-200mm/0-8"	±0.03mm	with	286mm	24mm	19mm	16mm	50mm
1114-300A*	0-300mm/0-12"	±0.03mm	with	400mm	25mm	20.5mm	17mm	60mm
1114-150AW*	0-150mm/0-6"	±0.03mm	without	236mm	21mm	16mm	16mm	40mm
1114-200AW*	0-200mm/0-8"	±0.03mm	without	286mm	24mm	19mm	16mm	50mm
1114-300AW*	0-300mm/0-12"	±0.03mm	without	400mm	25mm	20.5mm	17mm	60mm

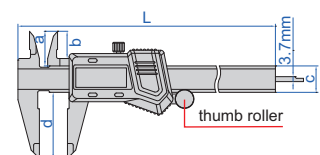

*Supplied with manufacturer inspection certificate

DATA
OUTPUT

INSPECTION
CERTIFICATE

DIGITAL CALIPERS (FRACTION READING)



1102-150

- Non waterproof
- Resolution: 1/128", 0.01mm, 0.0005"
- Buttons: unit (inch fraction/mm/inch), on/off, zero
- Automatic power off, move the digital unit to turn on power
- Battery CR2032
- Data output (for mm and inch)
- Meet DIN862
- Made of stainless steel
- Optional accessory:
wireless transmitter code **7315-25** (receiver is needed) page 5,
bluetooth transmitter code **7214-25** page 11,
data output cable code **7302-21** page 20,
accessory set for digital calipers
(code **6144**, only for range 0-150mm and 0-200mm),
depth base attachment (code **6140**)



inch fraction reading



mm reading



inch reading

Code	Range	Accuracy	Thumb roller	L	a	b	d
1102-150 *	0-150mm/0-6"	±0.02mm	with	236mm	21mm	16mm	40mm
1102-200 *	0-200mm/0-8"	±0.03mm	with	286mm	24mm	19mm	50mm
1102-300 *	0-300mm/0-12"	±0.03mm	with	400mm	25mm	20.5mm	60mm
1102-150W *	0-150mm/0-6"	±0.02mm	without	236mm	21mm	16mm	40mm
1102-200W *	0-200mm/0-8"	±0.03mm	without	286mm	24mm	19mm	50mm
1102-300W *	0-300mm/0-12"	±0.03mm	without	400mm	25mm	20.5mm	60mm

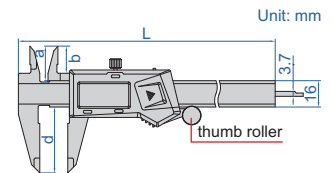

*Supplied with manufacturer inspection certificate

DATA
OUTPUT

INSPECTION
CERTIFICATE

HEAVY DUTY 300mm DIGITAL CALIPER



1196-300

- Non waterproof
- Resolution: 0.01mm/0.0005"
- Buttons: on/off, zero, mm/inch
- Automatic power off, move the digital unit to turn on power
- Battery CR2032
- Data output
- Meet DIN862
- Made of stainless steel
- Optional accessory:
wireless transmitter code **7315-22** (receiver is needed) page 5,
bluetooth transmitter code **7214-22** page 11,
data output cable code **7302-22** page 20

Code	Range	Thumb roller	Accuracy
1196-300 *	0-300mm/0-12"	with	±0.03mm
1196-300W *	0-300mm/0-12"	without	±0.03mm

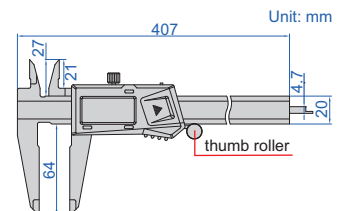

*Supplied with manufacturer inspection certificate

METRIC DIGITAL CALIPERS



LOCK READING WITH
"HOLD" BUTTON

DATA
OUTPUT

2

- Non waterproof
- Resolution: 0.01mm
- Buttons: on/off, zero, hold
- Automatic power off, move the digital unit to turn on power
- Battery CR2032
- Data output
- Meet DIN862
- Made of stainless steel
- Optional accessory:
 - wireless transmitter code **7315-25** (receiver is needed) page 5,
 - bluetooth transmitter code **7214-25** page 11,
 - data output cable code **7302-21** page 20,
 - accessory set for digital calipers (code **6144**, only for range 0-150mm and 0-200mm),
 - depth base attachment (code **6140**)



1109-150

Code	Range	Accuracy	Thumb roller	L	a	b	c	d
1109-150*	0-150mm	±0.03mm	with	236mm	21mm	16mm	16mm	40mm
1109-200*	0-200mm	±0.03mm	with	286mm	24mm	19mm	16mm	50mm
1109-300*	0-300mm	±0.03mm	with	400mm	25mm	20.5mm	16mm	60mm
1109-150W*	0-150mm	±0.03mm	without	236mm	21mm	16mm	16mm	40mm
1109-200W*	0-200mm	±0.03mm	without	286mm	24mm	19mm	16mm	50mm
1109-300W*	0-300mm	±0.03mm	without	400mm	25mm	20.5mm	16mm	60mm

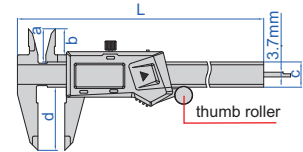

*Supplied with manufacturer inspection certificate

DIGITAL CALIPERS WITH ROUND DEPTH BAR



DATA
OUTPUT

- Non waterproof
- Resolution: 0.01mm/0.0005"
- Buttons: on/off, zero, mm/inch
- Automatic power off, move the digital unit to turn on power
- Battery CR2032
- Meet DIN862
- Made of stainless steel
- Optional accessory:
 - accessory set for digital calipers (code **6144**),
 - depth base attachment (code **6140**)



1119-150

With data interface
(optional data output cable: code 7315-25 receiver is needed page 5, 7214-25 page 11, 7302-21 page 20)

Code	Range	Accuracy	Thumb roller	L	a	b	c	d
1119-150*	0-150mm/0-6"	±0.03mm	with	236mm	21mm	16mm	16mm	40mm
1119-150W*	0-150mm/0-6"	±0.03mm	without	236mm	21mm	16mm	16mm	40mm

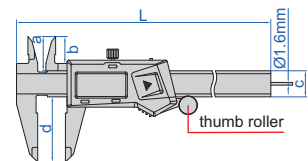

Built-in wireless (receiver code 7315-2/3/6/7/8/9 is needed)

Code	Range	Accuracy	Thumb roller	L	a	b	c	d
1119-150WL*	0-150mm/0-6"	±0.03mm	with	236mm	21mm	16mm	16mm	40mm
1119-150WWL*	0-150mm/0-6"	±0.03mm	without	236mm	21mm	16mm	16mm	40mm



round depth bar Ø1.6mm

*Supplied with manufacturer inspection certificate

DATA
OUTPUT

INSPECTION
CERTIFICATE

LEFT HAND DIGITAL CALIPERS

2

- Non waterproof
- Designed for left handed users
- Resolution: 0.01mm/0.0005"
- Buttons: on/off, zero, mm/inch
- Automatic power off, move the digital unit to turn on power
- Battery CR2032
- Data output
- Meet DIN862
- Made of stainless steel
- Optional accessory:
wireless transmitter code **7315-22** (receiver is needed) page 5,
bluetooth transmitter code **7214-22** page 11,
data output cable code **7302-22** page 20,
accessory set for digital calipers (code **6144**, only for range 0-150mm and 0-200mm),
depth base attachment (code **6140**)



1130-150

Code	Range	Accuracy	Thumb roller	L	a	b	d
1130-150*	0-150mm/0-6"	±0.03mm	with	236mm	21mm	16mm	40mm
1130-200*	0-200mm/0-8"	±0.03mm	with	286mm	24mm	19mm	50mm
1130-300*	0-300mm/0-12"	±0.03mm	with	400mm	25mm	20.5mm	60mm
1130-150W*	0-150mm/0-6"	±0.03mm	without	236mm	21mm	16mm	40mm
1130-200W*	0-200mm/0-8"	±0.03mm	without	286mm	24mm	19mm	50mm
1130-300W*	0-300mm/0-12"	±0.03mm	without	400mm	25mm	20.5mm	60mm

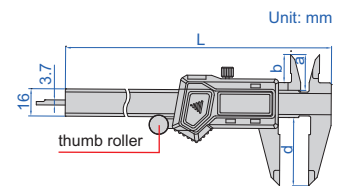

*Supplied with manufacturer inspection certificate

DATA
OUTPUT

INSPECTION
CERTIFICATE

DIGITAL CALIPERS WITH CERAMIC TIPPED JAWS

- Non waterproof
- Ceramic tipped jaws for outside measurement, extremely wear-resistant, non-magnetic and non electric conductive
- Resolution: 0.01mm/0.0005"
- Buttons: on/off, zero, mm/inch
- Automatic power off, move the digital unit to turn on power
- Battery CR2032, made of stainless steel
- Meet DIN862
- Optional accessory:
depth base attachment (code **6140**)



1193-150

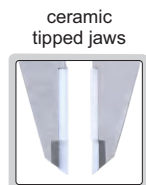
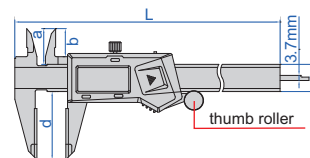

With data interface

(optional data output cable: code **7315-25** receiver is needed page 5, **7214-25** page 11, **7302-21** page 20)

Code	Range	Accuracy	Thumb roller	L	a	b	c	d
1193-150*	0-150mm/0-6"	±0.03mm	with	235mm	21mm	16.5mm	16mm	40mm
1193-200*	0-200mm/0-8"	±0.03mm	with	287mm	24mm	20mm	16mm	50mm
1193-300*	0-300mm/0-12"	±0.03mm	with	390mm	26mm	21.5mm	16mm	60mm
1193-150W*	0-150mm/0-6"	±0.03mm	without	235mm	21mm	16.5mm	16mm	40mm
1193-200W*	0-200mm/0-8"	±0.03mm	without	297mm	24mm	20mm	16mm	50mm
1193-300W*	0-300mm/0-12"	±0.03mm	without	390mm	26mm	21.5mm	16mm	60mm

Built-in wireless (receiver code **7315-2/3/6/7/8/9** is needed)

Code	Range	Accuracy	Thumb roller	L	a	b	c	d
1193-150WL*	0-150mm/0-6"	±0.03mm	with	235mm	21mm	16.5mm	16mm	40mm
1193-200WL*	0-200mm/0-8"	±0.03mm	with	287mm	24mm	20mm	16mm	50mm
1193-300WL*	0-300mm/0-12"	±0.03mm	with	390mm	26mm	21.5mm	16mm	60mm
1193-150WWL*	0-150mm/0-6"	±0.03mm	without	235mm	21mm	16.5mm	16mm	40mm
1193-200WWL*	0-200mm/0-8"	±0.03mm	without	297mm	24mm	20mm	16mm	50mm
1193-300WWL*	0-300mm/0-12"	±0.03mm	without	390mm	26mm	21.5mm	16mm	60mm

*Supplied with manufacturer inspection certificate

DIGITAL CALIPERS WITH CARBIDE TIPPED JAWS

2

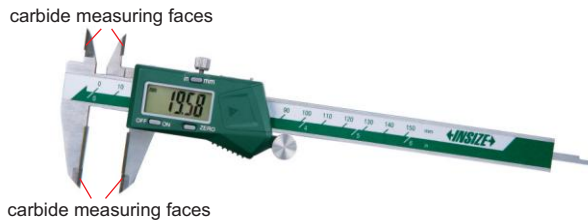

1110-150A

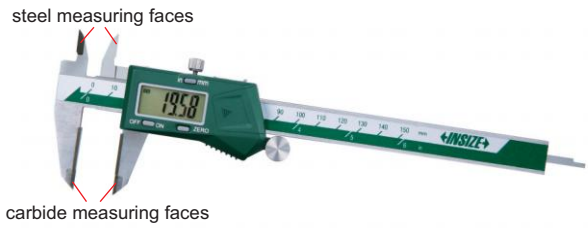

1110-150B

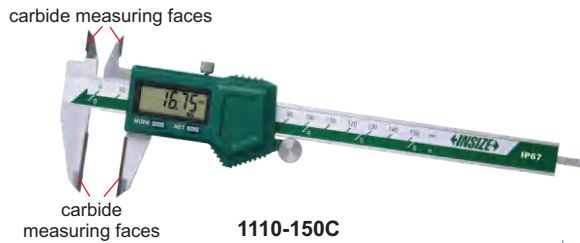

1110-150C

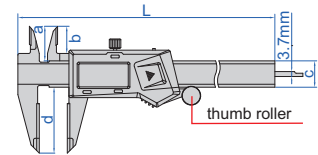

- Resolution: 0.01mm/0.0005"
- Buttons: on/off, zero, mm/inch
- Automatic power off, move the digital unit to turn on power
- Battery CR2032
- Meet DIN862
- Made of stainless steel
- Optional accessory: depth base attachment (code 6140)

Non waterproof, with data interface

(optional data output cable: code 7315-25 receiver is needed page 5, 7214-25 page 11, 7302-21 page 20)

Code	Range	Accuracy	Thumb roller	L	a	b	c	d	Remark
1110-150A*	0-150mm/0-6"	±0.03mm	with	236mm	21mm	16mm	16mm	40mm	carbide tipped upper and lower jaws
1110-200A*	0-200mm/0-8"	±0.03mm	with	286mm	24mm	19mm	16mm	50mm	carbide tipped upper and lower jaws
1110-300A*	0-300mm/0-12"	±0.03mm	with	400mm	25mm	20.5mm	16mm	60mm	carbide tipped upper and lower jaws
1110-150AW*	0-150mm/0-6"	±0.03mm	without	236mm	21mm	16mm	16mm	40mm	carbide tipped upper and lower jaws
1110-200AW*	0-200mm/0-8"	±0.03mm	without	286mm	24mm	19mm	16mm	50mm	carbide tipped upper and lower jaws
1110-300AW*	0-300mm/0-12"	±0.03mm	without	400mm	25mm	20.5mm	16mm	60mm	carbide tipped upper and lower jaws
1110-150B*	0-150mm/0-6"	±0.03mm	with	236mm	21mm	16mm	16mm	40mm	carbide tipped lower jaws
1110-200B*	0-200mm/0-8"	±0.03mm	with	286mm	24mm	19mm	16mm	50mm	carbide tipped lower jaws
1110-300B*	0-300mm/0-12"	±0.03mm	with	400mm	25mm	20.5mm	16mm	60mm	carbide tipped lower jaws
1110-150BW*	0-150mm/0-6"	±0.03mm	without	236mm	21mm	16mm	16mm	40mm	carbide tipped lower jaws
1110-200BW*	0-200mm/0-8"	±0.03mm	without	286mm	24mm	19mm	16mm	50mm	carbide tipped lower jaws
1110-300BW*	0-300mm/0-12"	±0.03mm	without	400mm	25mm	20.5mm	16mm	60mm	carbide tipped lower jaws

Non waterproof, built-in wireless (receiver code 7315-2/3/6/7/8/9 is needed)

Code	Range	Accuracy	Thumb roller	L	a	b	c	d	Remark
1110-150AWL*	0-150mm/0-6"	±0.03mm	with	236mm	21mm	16mm	16mm	40mm	carbide tipped upper and lower jaws
1110-200AWL*	0-200mm/0-8"	±0.03mm	with	286mm	24mm	19mm	16mm	50mm	carbide tipped upper and lower jaws
1110-300AWL*	0-300mm/0-12"	±0.03mm	with	400mm	25mm	20.5mm	16mm	60mm	carbide tipped upper and lower jaws
1110-150AWWL*	0-150mm/0-6"	±0.03mm	without	236mm	21mm	16mm	16mm	40mm	carbide tipped upper and lower jaws
1110-200AWWL*	0-200mm/0-8"	±0.03mm	without	286mm	24mm	19mm	16mm	50mm	carbide tipped upper and lower jaws
1110-300AWWL*	0-300mm/0-12"	±0.03mm	without	400mm	25mm	20.5mm	16mm	60mm	carbide tipped upper and lower jaws
1110-150BWL*	0-150mm/0-6"	±0.03mm	with	236mm	21mm	16mm	16mm	40mm	carbide tipped lower jaws
1110-200BWL*	0-200mm/0-8"	±0.03mm	with	286mm	24mm	19mm	16mm	50mm	carbide tipped lower jaws
1110-300BWL*	0-300mm/0-12"	±0.03mm	with	400mm	25mm	20.5mm	16mm	60mm	carbide tipped lower jaws
1110-150BWWL*	0-150mm/0-6"	±0.03mm	without	236mm	21mm	16mm	16mm	40mm	carbide tipped lower jaws
1110-200BWWL*	0-200mm/0-8"	±0.03mm	without	286mm	24mm	19mm	16mm	50mm	carbide tipped lower jaws
1110-300BWWL*	0-300mm/0-12"	±0.03mm	without	400mm	25mm	20.5mm	16mm	60mm	carbide tipped lower jaws

IP67 dust/waterproof, without data interface

Code	Range	Accuracy	Thumb roller	L	a	b	c	d	Remark
1110-150C*	0-150mm/0-6"	±0.03mm	with	236mm	21mm	16mm	16mm	40mm	carbide tipped upper and lower jaws
1110-150D*	0-150mm/0-6"	±0.03mm	with	236mm	21mm	16mm	16mm	40mm	carbide tipped lower jaws
1110-150CW*	0-150mm/0-6"	±0.03mm	without	236mm	21mm	16mm	16mm	40mm	carbide tipped upper and lower jaws
1110-150DW*	0-150mm/0-6"	±0.03mm	without	236mm	21mm	16mm	16mm	40mm	carbide tipped lower jaws

*Supplied with manufacturer inspection certificate

DATA
OUTPUT

DIGITAL CALIPERS

- Non waterproof
- Resolution: 0.01mm/0.0005"
- Buttons: on/off, zero, mm/inch
- Automatic power off, move the digital unit to turn on power
- Battery CR2032
- Made of stainless steel



1170-300

With data interface (optional data output cable: code 7315-25 receiver is needed page 5, 7214-25 page 11, 7302-21 page 20)

Code	Range	Accuracy	a	c	d	e	L
1170-200	0-200mm/0-8"	±0.03mm	12mm	17mm	60mm	10mm	314mm
1170-306	0-300mm/0-12"	±0.04mm	12mm	17mm	60mm	10mm	420mm
1170-300	0-300mm/0-12"	±0.06mm	12mm	17mm	90mm	10mm	420mm

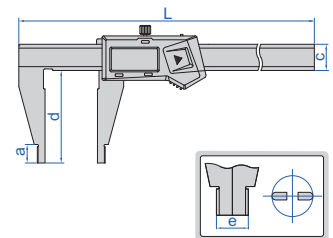

Built-in wireless (receiver code 7315-2/3/6/7/8/9 is needed)

Code	Range	Accuracy	a	c	d	e	L
1170-200WL	0-200mm/0-8"	±0.03mm	12mm	17mm	60mm	10mm	314mm
1170-306WL	0-300mm/0-12"	±0.04mm	12mm	17mm	60mm	10mm	420mm
1170-300WL	0-300mm/0-12"	±0.06mm	12mm	17mm	90mm	10mm	420mm

DATA
OUTPUT

DIGITAL CALIPERS

- Non waterproof
- Resolution: 0.01mm/0.0005"
- Buttons: on/off, zero, mm/inch
- Automatic power off, move the digital unit to turn on power
- Battery CR2032
- Made of stainless steel



1171-300

With data interface (optional data output cable: code 7315-25 receiver is needed page 5, 7214-25 page 11, 7302-21 page 20)

Code	Range	Accuracy	a	b	c	d	e	L
1171-200	0-200mm/0-8"	±0.03mm	12mm	38mm	17mm	60mm	10mm	320mm
1171-250	0-250mm/0-10"	±0.03mm	12mm	38mm	17mm	60mm	10mm	365mm
1171-306	0-300mm/0-12"	±0.04mm	12mm	38mm	17mm	60mm	10mm	420mm
1171-300	0-300mm/0-12"	±0.06mm	12mm	38mm	17mm	90mm	10mm	420mm

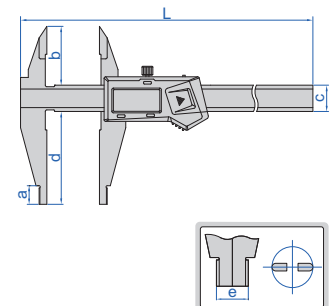

Built-in wireless (receiver code 7315-2/3/6/7/8/9 is needed)

Code	Range	Accuracy	a	b	c	d	e	L
1171-200WL	0-200mm/0-8"	±0.03mm	12mm	38mm	17mm	60mm	10mm	320mm
1171-250WL	0-250mm/0-10"	±0.03mm	12mm	38mm	17mm	60mm	10mm	365mm
1171-306WL	0-300mm/0-12"	±0.04mm	12mm	38mm	17mm	60mm	10mm	420mm
1171-300WL	0-300mm/0-12"	±0.06mm	12mm	38mm	17mm	90mm	10mm	420mm

MINI DIGITAL CALIPERS

ATTENTION:
NO DATA OUTPUT

2

- Non waterproof
- Resolution: 0.01mm/0.0005"
- Buttons: zero, mm/inch, on/off
- Automatic power off, move the digital unit to turn on power
- Battery LR44
- Meet DIN862
- Made of stainless steel



1111-100A

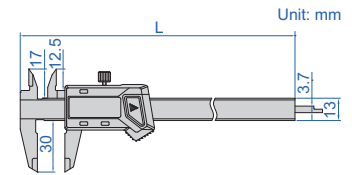

Code	Range	Accuracy	L
1111-75A	0-75mm/0-3"	±0.02mm	144mm
1111-100A	0-100mm/0-4"	±0.02mm	170mm

PLASTIC DIGITAL CALIPER

ATTENTION:
NO DATA OUTPUT

- Non waterproof
- Made of hard plastic, non-magnetic and non electric conductive
- Prevent workpieces from scratching by calipers
- Resolution: 0.01mm/0.0005"
- Buttons: on/off, zero, mm/inch
- Battery CR2032, automatic power off



1139-150

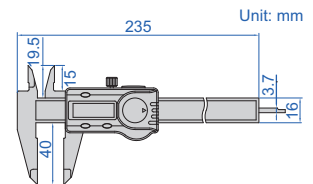

Code	Range	Accuracy
1139-150	0-150mm/0-6"	±0.1mm

MINI VERNIER CALIPERS

- Meet DIN862
- Made of stainless steel
- Satin chrome plated reading surface

Code	Range	Graduation	Accuracy
1204-70	0-70mm	0.05mm	±0.05mm

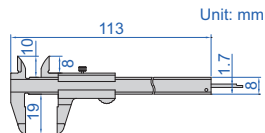

1204-70



Code	Range	Graduation	Accuracy
1203-1003	0-100mm	0.05mm	±0.05mm

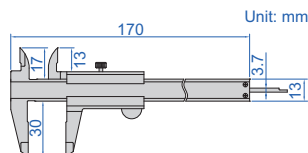

1203-1003



Code	Range	Graduation	Accuracy
1201-1003	0-100mm	0.05mm	±0.05mm

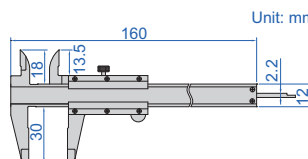

1201-1003



DATA
OUTPUT

POPULAR
MODEL

DIGITAL CALIPERS

2



1106-501

- Non waterproof
- Resolution: 0.01mm/0.0005"
- Button function: on/off, zero, mm/inch, ABS, data preset
- Battery CR2032
- Made of stainless steel
- Optional accessory: accessory set for large digital calipers (code **6145-500/6146-500B**, for calipers with c=24mm)

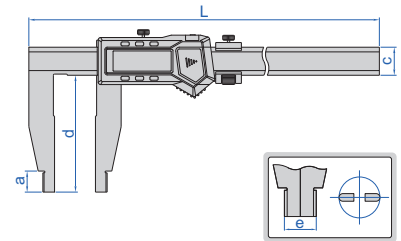

With data interface

(mm)

Code	Range	Accuracy	a	c	d	e	L	Data output cable (optional)
1106-301	0-300mm/0-12"	±0.05mm	18	24	100	20	420	7315-22 (receiver is needed) page 5, 7214-22 page 11, 7302-22 page 20
1106-302	0-300mm/0-12"	±0.05mm	18	24	150	20	475	
1106-451	0-450mm/0-18"	±0.05mm	18	24	100	20	625	
1106-501	0-500mm/0-20"	±0.05mm	18	24	100	20	675	
1106-502	0-500mm/0-20"	±0.06mm	18	24	150	20	675	
1106-503	0-500mm/0-20"	±0.06mm	24	31	200	20	675	7315-20B (receiver is needed), 7302-SPC1A
1106-505	0-500mm/0-20"	±0.08mm	24	42	300	20	675	
1106-601	0-600mm/0-24"	±0.05mm	18	24	100	20	770	7315-22 (receiver is needed) page 5, 7214-22 page 11, 7302-22 page 20
1106-602	0-600mm/0-24"	±0.06mm	18	24	150	20	770	
1106-603	0-600mm/0-24"	±0.06mm	24	31	200	20	825	
1106-802	0-800mm/0-32"	±0.07mm	24	31	150	20	1025	
1106-1002	0-1000mm/0-40"	±0.08mm	24	31	150	20	1220	
1106-1003	0-1000mm/0-40"	±0.08mm	24	31	200	20	1220	7315-20B (receiver is needed), 7302-SPC1A
1106-1005	0-1000mm/0-40"	±0.10mm	24	42	300	20	1220	
1106-1502	0-1500mm/0-60"	±0.11mm	24	42	150	20	1780	
1106-1503	0-1500mm/0-60"	±0.12mm	24	42	200	20	1780	
1106-2002	0-2000mm/0-80"	±0.14mm	24	42	150	20	2290	
1106-2003	0-2000mm/0-80"	±0.14mm	24	42	200	20	2290	
1106-2502	0-2500mm/0-100"	±0.22mm	24	42	150	20	2800	
1106-3002	0-3000mm/0-120"	±0.26mm	24	42	150	20	3300	

Built-in wireless (receiver code 7315-2/3/6/7/8/9 is needed)

Code	Range	Accuracy	a	c	d	e	L
1106-301WL	0-300mm/0-12"	±0.05mm	18mm	24mm	100mm	20mm	420mm
1106-302WL	0-300mm/0-12"	±0.05mm	18mm	24mm	150mm	20mm	420mm
1106-451WL	0-450mm/0-18"	±0.05mm	18mm	24mm	100mm	20mm	625mm
1106-501WL	0-500mm/0-20"	±0.05mm	18mm	24mm	100mm	20mm	675mm
1106-502WL	0-500mm/0-20"	±0.06mm	18mm	24mm	150mm	20mm	675mm
1106-601WL	0-600mm/0-24"	±0.05mm	18mm	24mm	100mm	20mm	770mm
1106-602WL	0-600mm/0-24"	±0.06mm	18mm	24mm	150mm	20mm	770mm

DIGITAL CALIPERS

DATA OUTPUT



1117-501

- Non waterproof
- Resolution: 0.01mm/0.0005"
- Button function: on/off, zero, mm/inch, ABS, data preset
- Battery CR2032
- Made of stainless steel
- Optional accessory: accessory set for large digital calipers (code 6145-500/6146-500B, for calipers with c=24mm)

With data interface (optional data output cable: code 7315-22 receiver is needed page 5, 7214-22 page 11, 7302-22 page 20)

Code	Range	Accuracy	a	b	c	d	e	L
1117-301	0-300mm/0-12"	±0.05mm	18mm	56mm	24mm	100mm	20mm	420mm
1117-501	0-500mm/0-20"	±0.05mm	18mm	56mm	24mm	100mm	20mm	675mm
1117-502	0-500mm/0-20"	±0.06mm	24mm	56mm	24mm	150mm	20mm	675mm
1117-601	0-600mm/0-24"	±0.05mm	18mm	56mm	24mm	100mm	20mm	770mm
1117-802	0-800mm/0-32"	±0.07mm	24mm	67mm	31mm	150mm	20mm	1025mm
1117-1002	0-1000mm/0-40"	±0.08mm	24mm	67mm	31mm	150mm	20mm	1220mm

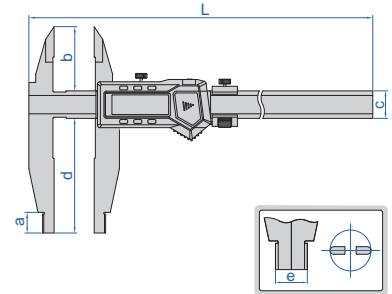

Built-in wireless (receiver code 7315-2/3/6/7/8/9 is needed)

Code	Range	Accuracy	a	b	c	d	e	L
1117-301WL	0-300mm/0-12"	±0.05mm	18mm	56mm	24mm	100mm	20mm	420mm
1117-501WL	0-500mm/0-20"	±0.05mm	18mm	56mm	24mm	100mm	20mm	675mm
1117-502WL	0-500mm/0-20"	±0.06mm	24mm	56mm	24mm	150mm	20mm	675mm
1117-601WL	0-600mm/0-24"	±0.05mm	18mm	56mm	24mm	100mm	20mm	770mm

DIGITAL CALIPERS

DATA OUTPUT



1136-501

- Non waterproof
- Resolution: 0.01mm/0.0005"
- Button function: on/off, zero, mm/inch, ABS, data preset
- Battery CR2032
- Made of stainless steel
- Optional accessory: accessory set for large digital calipers (code 6145-500/6146-500B, for calipers with c=24mm)

With data interface (optional data output cable: code 7315-22 receiver is needed page 5, 7214-22 page 11, 7302-22 page 20, for calipers with c=24mm or 31mm)

Code	Range	Accuracy	a	b	c	d	L
1136-301	0-300mm/0-12"	±0.05mm	18	45	24	100	420
1136-451	0-450mm/0-18"	±0.05mm	18	45	24	100	625
1136-501	0-500mm/0-20"	±0.05mm	18	45	24	100	675
1136-502	0-500mm/0-20"	±0.06mm	18	45	24	150	675
1136-503	0-500mm/0-20"	±0.06mm	24	60	31	200	675
1136-601	0-600mm/0-24"	±0.05mm	18	45	24	100	770
1136-1002	0-1000mm/0-40"	±0.08mm	24	60	31	150	1220
1136-1502	0-1500mm/0-60"	±0.11mm	24	60	42	150	1780
1136-2002	0-2000mm/0-80"	±0.14mm	24	60	42	150	2290

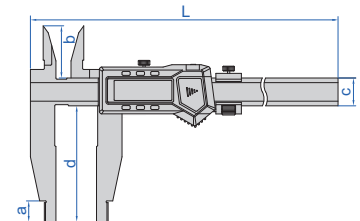
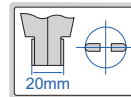

Built-in wireless (receiver code 7315-2/3/6/7/8/9 is needed)

Code	Range	Accuracy	a	b	c	d	L
1136-301WL	0-300mm/0-12"	±0.05mm	18	45	24	100	420
1136-451WL	0-450mm/0-18"	±0.05mm	18	45	24	100	625
1136-501WL	0-500mm/0-20"	±0.05mm	18	45	24	100	675
1136-502WL	0-500mm/0-20"	±0.06mm	18	45	24	150	675
1136-601WL	0-600mm/0-24"	±0.05mm	18	45	24	100	770

DATA OUTPUT
DIGITAL CALIPERS

1135-601

- Non waterproof
- Resolution: 0.01mm/0.0005"
- Button function: on/off, zero, mm/inch, ABS, data preset
- Battery CR2032
- Made of stainless steel

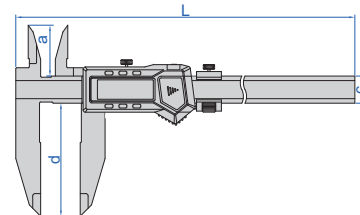

With data interface (optional data output cable:
code 7315-22 receiver is needed page 5,
7214-22 page 11, 7302-22 page 20)

Code	Range	Accuracy	a	c	d	L
1135-451	0-450mm/0-18"	±0.05mm	45	24	100	625
1135-601	0-600mm/0-24"	±0.05mm	45	24	100	770
1135-1002	0-1000mm/0-40"	±0.08mm	60	31	150	1220

Built-in wireless
(receiver code 7315-2/3/6/7/8/9 is needed)

Code	Range	Accuracy	a	c	d	L
1135-451WL	0-450mm/0-18"	±0.05mm	45	24	100	625
1135-601WL	0-600mm/0-24"	±0.05mm	45	24	100	770

VERNIER CALIPERS (SOLID TYPE)

- With fine adjustment
- Made of stainless steel
- Satin chrome plated reading surface

1236-521

solid type
(without screw)

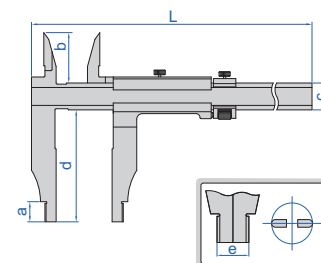

Graduation 0.05mm/1/128" (mm)

Code	Range	Accuracy	a	b	c	d	e	L
1236-394	0-300mm/0-12"	±0.07mm	12	38	20	90	10	450
1236-514	0-500mm/0-20"	±0.07mm	18	45	24	100	20	670
1236-524	0-500mm/0-20"	±0.08mm	18	45	24	150	20	670
1236-614	0-600mm/0-24"	±0.08mm	18	45	24	100	20	770
1236-824	0-800mm/0-32"	±0.09mm	24	60	31	150	20	1030
1236-1024	0-1000mm/0-40"	±0.12mm	24	60	31	150	20	1230

Graduation 0.02mm (mm)

Code	Range	Accuracy	a	b	c	d	e	L
1236-511	0-500mm	±0.05mm	18	45	24	100	20	670
1236-521	0-500mm	±0.06mm	18	45	24	150	20	670
1236-1021	0-1000mm	±0.08mm	24	60	31	150	20	1230

VERNIER CALIPERS (SOLID TYPE)

- Graduation 0.05mm/1/128"
- With fine adjustment
- Made of stainless steel
- Satin chrome plated reading surface

1207-514

(mm)

Code	Range	Accuracy	a	b	c	d	e	L
1207-394	0-300mm/0-12"	±0.07mm	12	40	20	90	10	440
1207-514	0-500mm/0-20"	±0.07mm	18	56	24	100	20	670
1207-524	0-500mm/0-20"	±0.08mm	18	56	24	150	20	670
1207-824	0-800mm/0-32"	±0.09mm	24	67	31	150	20	930
1207-1024	0-1000mm/0-40"	±0.12mm	24	67	31	150	20	1230

solid type
(without screw)

